

Single-phase Smart Meter

USER MANUAL

DDSU666 (CT × 100 A)

CONTENTS

1 Safety Instruction	3
1.1 Safety Symbols	3
1.2 Personnel Requirements	4
1.3 Product-related Requirements	4
1.4 Disclaimer	4
1.5 Maintenance and Replacement	4
2 Product Introduction	5
2.1 Product Overview	5
2.2 Product Naming Rule	5
2.3 Working Principle	5
2.4 Main Function	6
2.4.1 Metering Function	6
2.4.2 Display Function	6
2.4.3 Communication Function	8
2.4.4 Output Function	8
2.5 Product Dimensions	8
2.6 Product Installation	9
3 Troubleshooting	10
4 Technical Specification	10
4.1 Percentage Error	10
4.2 Start	11
4.3 Defluction	11
4.4 Environmental Parameter	11
4.5 Electrical Parameter	11
4.6 Technical Parameter	12

1 Safety Instruction

1.1 Safety Symbols

The following types of safety precautions and general information symbols in this manual must be followed during the installation, operation, and maintenance.

Symbol	Usage
	Indicates a hazard with a high level of risk that, if not avoided, will result in death or serious injury.
	Indicates a hazard with a medium level of risk that, if not avoided, can result in death or serious injury.
	Indicates a hazard with a low level of risk that, if not avoided, can result in minor or moderate injury.
	Indicates a situation that, if not avoided, can result in property damage. NOTICE is used to address practices not related to personal injury.
	Caution! Failure to observe any warnings contained in this manual may result in injury.
	Danger to life due to high voltages! Only qualified personnel can open and maintain the inverter.
	Burn danger due to hot surface that may exceed 60°C.
	Refer to the operating instructions.
	Products shall not be disposed of as household waste.

1.2 Personnel Requirements

This document is only applicable to qualified personnel who have received professional training and possess the following skills:

- Knowledge of and compliance with this document and all safety instructions.
- Familiar with all safety specifications of the electrical system.
- Understanding of the composition and working principles of the grid-tied PV power system and local regulations.
- Proficiency in energy meter installation, operation, and maintenance.

Note:

- The qualified personnel must wear personal protective equipment (PPE) during all operations.
- The qualified personnel should comply with local laws and regulations during installation and operation. The safety instructions in this document are only supplements to laws and regulations.

1.3 Product-related Requirements

- When transporting and unpacking the products, please confirm they are not severely impacted.
- The package of the meter should use materials that can meet environmental requirements.
- The instrument and accessories shall be stored in dry and ventilated places, to avoid humidity and corrosive gas erosion. The storage environment temperature is -40°C to 70°C, and the relative humidity should be no more than 75%.
- Transport and store the product based on transportation, basic environmental conditions, and testing methods for instruments and meters of JB/T9329-1999.
- The package should meet the standards in GB/T 133384-2008, and the conventional storage and transportation environment should meet the standards in GB/T 25480-2010.

1.4 Disclaimer

Hoymiles shall not be liable for the following situations:

- Any damage caused by incorrect installation and operation.
- Any damage caused by improper transportation and storage.
- Any damage caused by unauthorized modifications to the product.
- Any installation, operation, and maintenance performed by unqualified personnel.
- Failure to comply with all safety and operation instructions described in this document.

1.5 Maintenance and Replacement

- Disconnect the power supply before any maintenance and repair operation.
- All maintenance and replacement operations must be performed by qualified personnel.
- It is recommended to carry out regular inspection and maintenance for safety reasons.
- If users find any quality problem within 18 months from the date of dispatch, Hoymiles is responsible for repairing or replacing it for free, on the condition that users operate the product according to the manual's provision, and the seal is intact.

2 Product Introduction

2.1 Product Overview

Type DDSU666 single-phase electronic energy meter (Din-rail) (hereinafter referred to as the “instrument”) is designed based on power monitoring and energy metering demands for electric power system as a new generation of intelligent instrument combining measurement and communication function, mainly applied to the measurement and display for the electric parameters in the electric circuit including voltage, current, power, frequency, power factor, active energy, etc. The network can be realized through the RS485 communication interface with the external device. Adopting the standard DIN35 mm din rail mounting and modular design, it is characterized by small volume, easy installation, and networking, widely applied to the internal energy monitoring and assessment for industrial and mining enterprises, hotels, schools, and large public buildings.

This type of energy meter conforms to the following standards:

- IEC 61010-1:2010 《Safety requirements for electrical requirement for measurement, control, and laboratory use Part1: General requirements》;
- IEC 61326-1:2013 《Electrical requirement for measurement, control, and laboratory use-EMC requirements Part1: General requirements》;
- MODBUS-RTU protocol.

2.2 Product Naming Rule

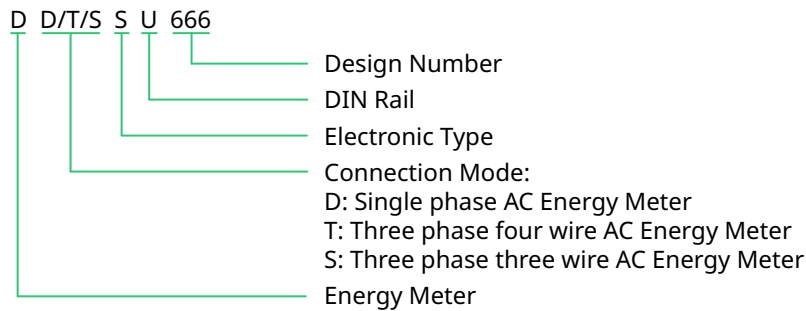

Figure 2-1 Product Naming Rule

Table 2-1 Model Specification

Model	Accuracy Grade	Referenced Voltage	Current Specification	Constant	Type
DDSU666 (CT-100 A)	Active Power 1	230 V	100 A/40 mA	800 imp/kWh	Transformer Access

2.3 Working Principle

The working principle block diagram of the instrument is shown in Figure 2-2:

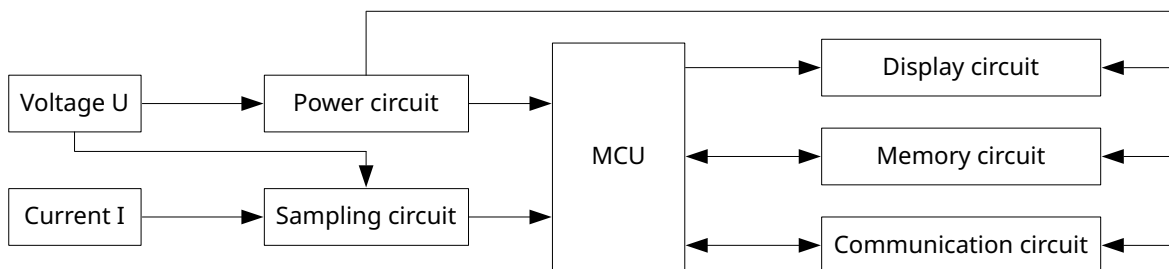

Figure 2-2 Working Principle Diagram

2.4 Main Function

2.4.1 Metering Function

Accurately metering the positive/reverse active energy and combined active energy, no storage data loss for the meter after power interruption.

2.4.2 Display Function

The instrument adopts a field LCD design, characterized by a display function for electrical parameters and energy data. Please see the LCD shown in Figure 2-3.

The display bit of energy measurement value can be six bits, with display ranging from 0 to 999999 kWh.

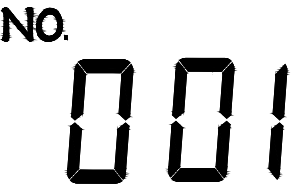
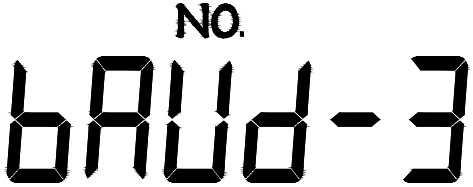

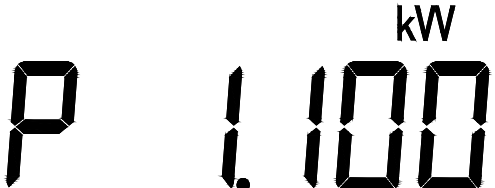



Figure 2-3 Liquid Crystal Display

The display time of the measurement data is 5s. Please see the display items shown in the table 2-2.

Table 2-2 Display Interface

No.	Display Interface	Description
1	<p>Imp. kWh</p>	Current positive active energy Imp=1.20 kWh
2	<p>Exp. kWh</p>	Current reverse active energy Exp=1.00 kWh
3	<p>NO.</p>	Modbus
4	<p>NO.</p>	8 Data bits, None Parity, 1 Stop Bit

5		Comm.Add=1
6		baud rate to be 9600 bps
7		Voltage U=220.0 V
8		Current I=5.000 A
9		Active power P=1.100 kW
10		Power factor Ft=1.000
11		Frequency F=50.00 Hz

Note:

1. The meter can set the communication address and baud rate through buttons.

Long press the button 3s, and the meter will automatically enter into the communication address setting interface, with a cyclic display for setting the display interface of baud rate and communication address.

Please press the button when required for baud rate or communication address settings, it will exit to communication address and baud rate settings without button operation for twenty seconds.

The details are as follows:

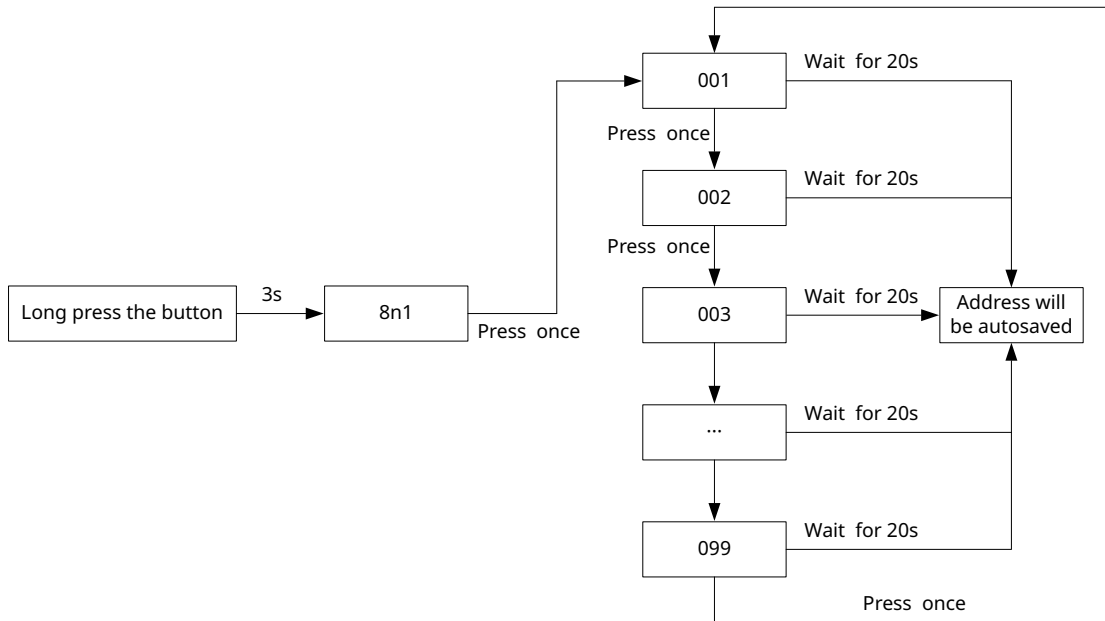

Figure 2-4 Communication address and baud rate setting diagram

2. The communication address can also be set through the S-Miles App. Open the S-Miles App, tap “Toolkit → Meter Location”, and enter the serial number of the smart meter, the communication address will be automatically set to 002. If two meters are required for an AC-coupled system, the address of the grid side meter should be set to 002, and the address of the PV side meter should be set to 001.

2.4.3 Communication Function

The meter is equipped with one RS485 communication interface, with the baud rate changed between 1200 bps and 9600 bps. The default baud rate is 9600 bps with check bit and stop bit to be n.1; the factory default communication address is 001; it supports Modbus-RTU protocol.

2.4.4 Output Function

The electric energy pulse output interface of the interface of the meter is a passive photoelectric isolated output, and the output pulse waveform is 80+16 ms square wave.

Meter pulse indication uses a long-life LED display.

2.5 Product Dimensions

Table 2-3 Product Structure

Model	Outline Size (W × H × D)	Installation Size (Din-rail)
DTSU666 (CT × 100 A)	36 × 100 × 65 mm	DIN35 standard din-rail

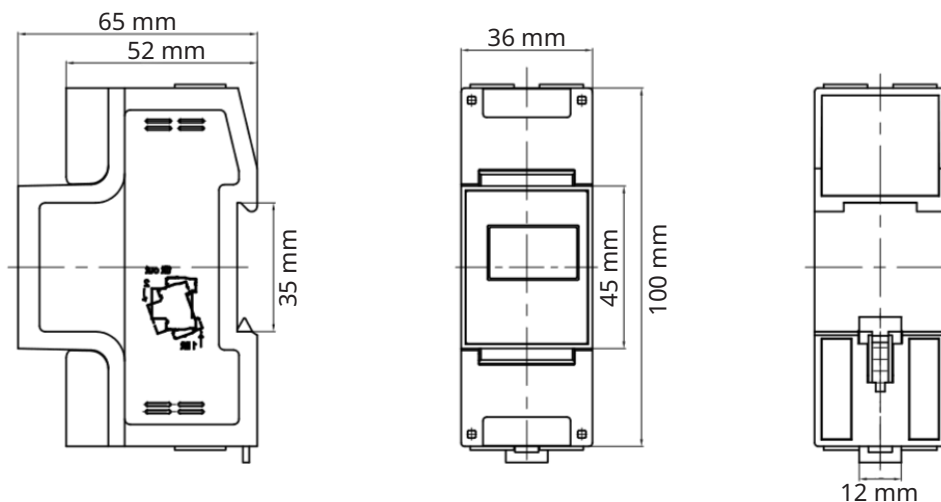



Figure 2-5 Product Dimensions

2.6 Product Installation

	<ul style="list-style-type: none"> Before connecting the cables, ensure that the smart meter is not damaged in any way. Otherwise, electric shocks or fires may occur.
	<ul style="list-style-type: none"> Before installation, please check whether the model and specifications of the products on the box are in line with the material; if not, please contact the supplier. Check whether the packing case of the product is damaged, if damaged, please contact the supplier. When unpacking the carton, if the shell has obvious signs caused by severe impact or falling, please contact the supplier as soon as possible. After the instrument is removed from the packing box, it should be placed in a flat and safe place, facing up, not overlaying for more than five layers; if the inner package or shell has been damaged, please do not install the product.

Procedure (Hybrid System)

<p>Steps</p>	<ul style="list-style-type: none"> Clamp the meter to the guide rail directly, and install the meter and the rail in or near the distribution box, right after the utility meter. Connect grid L/N to meter's terminals 3/4. Clamp CT to L line and respectively connect wirings to terminals 5/6. The arrow on the surface of CT should point to the grid. Connect the communication cable to terminals 24/25.
--------------	---

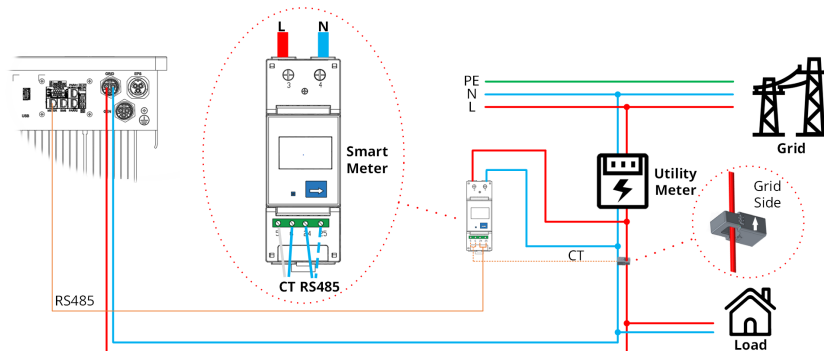

Procedure (AC-coupled System)

<p>Steps</p>	<ul style="list-style-type: none"> The smart meter 1 is connected to the grid port, and the smart meter 2 is connected to the GEN port. The connection method is the same as that described above.
--------------	---

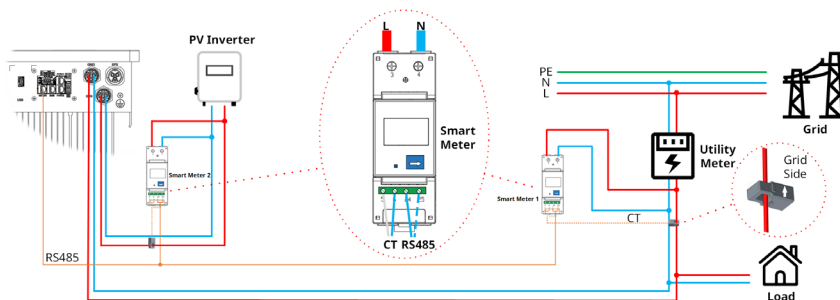

Note:

- When installing, clip the end of the card slot into the guide rail.
- When disassembling, use a screwdriver to press the card to remove the instrument.

3 Troubleshooting

Fault Phenomenon	Factor Analysis	Elimination Method
No display after the instrument is powered on	<ul style="list-style-type: none"> Incorrect wiring mode. Abnormal voltage supplied for the instrument. 	<ul style="list-style-type: none"> If the wiring mode is incorrect, please reconnect based on the correct wiring mode (see the wiring diagram). If the supplied voltage is abnormal, please supply the voltage on the instrument specification.
Abnormal RS485 communication	<ul style="list-style-type: none"> The RS485 communication cable is disconnected, short-circuited, or reversely connected. The address, baud rate, data bit and parity bit of the instrument are not in accordance with the host computer. 	<ul style="list-style-type: none"> If there is any problem with the communication cable, please reconnect or change the cable. Set the address, baud rate, data bit, and parity bit to be the same as the host computer through buttons; for button settings, please see "parameter setting".
Inaccurate energy metering	<ul style="list-style-type: none"> Incorrect wiring, please check whether the phase sequence corresponding to the voltage and current is correct. Check whether the high-end and low-end of the current transformer inlet are reversely connected. The power of Pa, Pb, and Pc will be abnormal if there is any negative value. 	<ul style="list-style-type: none"> If the wiring mode is incorrect, please reconnect based on the correct wiring mode (see the wiring diagram). If the fault still exists, please contact the local supplier.

4 Technical Specification

4.1 Percentage Error

The percentage error of a single-phase electric meter shall not exceed the following limit value.

Current Value		Power Factor	Percent Error limit of Each Level Meter
Direct connection	Connection through current transformer		Class 1
$0.05 I_b \leq I < 0.1 I_b$	$0.02 I_n \leq I < 0.05 I_n$	1	± 1.5
$0.1 I_b \leq I \leq I_{max}$	$0.05 I_n \leq I \leq I_{max}$	1	± 1.0
$0.1 I_b \leq I < 0.2 I_b$	$0.05 I_n \leq I < 0.1 I_n$	0.5L	± 1.5
		0.8C	± 1.5

0.2 $I_b \leq I \leq I_{max}$	0.1 $I_n \leq I \leq I_{max}$	0.5L	± 1.0
		0.8C	± 1.0
The user's special requirements		0.25L	± 3.5
0.2 $I_b \leq I \leq I_{max}$	0.1 $I_n \leq I \leq I_{max}$	0.5C	± 2.5

4.2 Start

Under the condition of reference voltage, the electric meter can start and continuously measure the electric energy.

Type	Electric Meter Grade	Power Factor
	Grade 1	
Direct connection	0.004 I_b	1
Connection through current transformer	0.002 I_n	

4.3 Deflection

When the voltage is applied with no current flowing in the current circuit, the test output of the meter shall not produce more than one pulse. When testing, the current circuit shall be disconnected, and the applied voltage of the voltage circuit shall be 115% of the referenced voltage.

4.4 Environmental Parameter

Regulated working temperature range	-25°C-60°C
Limited working temperature range	-35°C-70°C
Relative humidity (annual average)	$\leq 75\%$
Atmospheric pressure	86 kPa-106 kPa

4.5 Electrical Parameter

Specified operating voltage range	0.9 U_n -1.1 U_n
Extended operating voltage range	0.7 U_n -1.15 U_n
Limiting operating voltage range	0.7 U_n -1.3 U_n
Voltage line power consumption	≤ 2 W/10 VA
Current line power consumption	≤ 2.5 VA

4.6 Technical Parameter

Model	DDSU666 (CT-100 A)
Power Supply	
Grid type	1P2W
Input voltage (phase voltage)	154 Vac - 286 Vac
Power consumption	≤ 1.5 W
Measuring Range	
Phase voltage	154 Vac - 286 Vac
Current	0 - 100 A
Measuring Accuracy	
$0.01 I_n \leq I < 0.05 I_n^{(1)}$	±1.5 %
$0.05 I_n \leq I \leq I_n^{(1)}$	±1.0 %
Communication	
Interface	RS485
Communication protocol	Modbus-RTU
Mechanical Data	
Wiring type	Via-CT
Ambient temperature range	-25°C - 70°C
Dimensions (W × H × D)	36 × 100 × 65 mm
Mounting type	DIN35 Rail
CT Data	
Thread	Single turn
Install	Buckle
Ambient temperature range	-25°C - 70°C
Dimensions (W × H × D)	30 × 45 × 32 mm
Cable length	6 m

(1) Secondary rated current of the current transformer.



Floor 6-10, Building 5, 99 Housheng Road, Gongshu District,
Hangzhou 310015
P. R. China
+86 571 2805 6101

General inquiry: info@hoymiles.com
Technical support: service@hoymiles.com

Visit <https://www.hoymiles.com/> for more informations.